

9900 Series/Surface Mount Reed Relays

NEW!

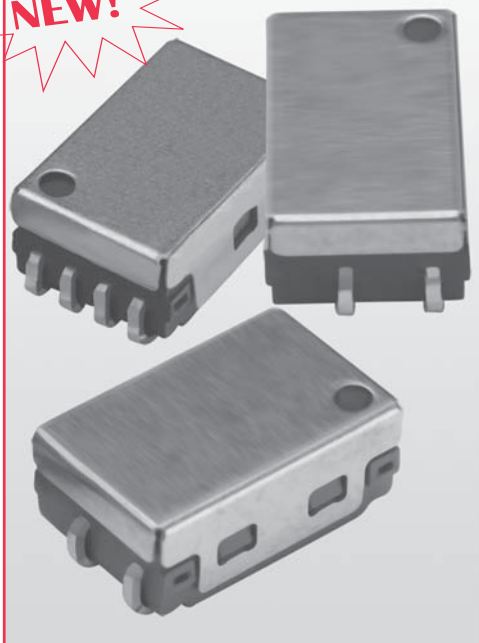

SURFACE MOUNT REED RELAYS

Ideally suited to the needs of Automated Test Equipment and Instrumentation requirements, Coto's 9900 Series is the smallest Surface Mount Reed Relay available. The external Magnetic Shield reduces interaction between parts in high density boards. Small size plus the use of Coto's proprietary switch technology make these relays ideal for designs such as high speed, high pin count VLSI testers where speed, size and performance are all needed.

SERIES FEATURES

- ◆ Available in Axial, Gull wing and "J" lead configurations
- ◆ Tape and Reel packaging available
- ◆ High reliability, hermetically sealed contacts for long life
- ◆ High Insulation Resistance - $10^{12} \Omega$ minimum
- ◆ Coaxial shield for 50 Ω impedance
- ◆ 6.5 GHz bandwidth for RF and Pulse switching (fast rise time pulses) [9903 only]
- ◆ External Magnetic Shield

Model 9901
(Top View)

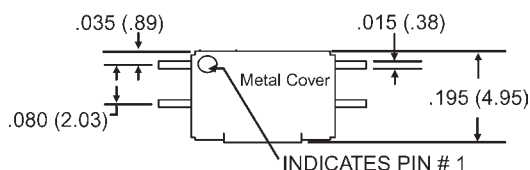

Model 9903
(Top View)

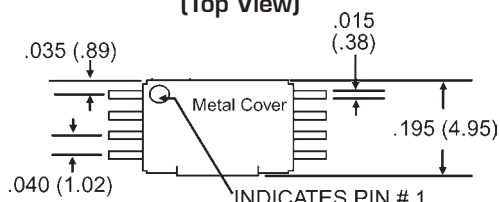

Axial²

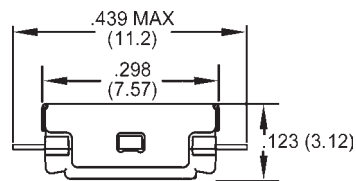

J-Lead²

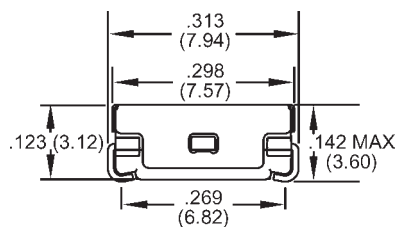

Gull Wing²
(Call factory for availability)

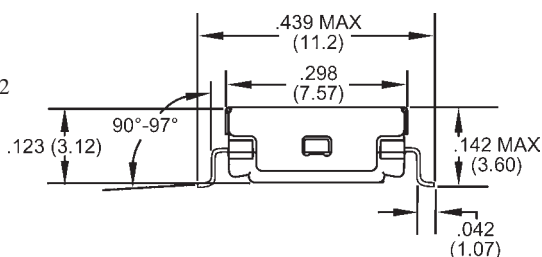

Dimensions in Inches (Millimeters)

Ordering Information

Part Number	99XX-XX-XX
Model Number	Lead Style
9901 (4-pin, no shield)	00 = Gull Wing (Call factory for availability)
9903 (8-pin, coax shield)	10 = Axial
Coil Voltage	20 = J-Lead
05 = 5 volts	

9900 Series/Surface Mount Reed Relays

NEW!

Model Number			9901	9903
Parameters	Test Conditions	Units	1 Form A	1 Form A 50 Ω Coaxial
COIL SPECIFICATIONS				
Nom. Coil Voltage		VDC	5	5
Max. Coil Voltage		VDC	6	6
Coil Resistance	+/- 10%, 25° C	Ω	150	150
Operate Voltage	Must Operate by	VDC - Max.	3.8	3.8
Release Voltage	Must Release by	VDC - Min.	0.4	0.4
CONTACT RATINGS				
Switching Voltage	Max DC/Peak AC Resist.	Volts	100	100
Switching Current	Max DC/Peak AC Resist.	Amps	0.25	0.25
Carry Current	Max DC/Peak AC Resist.	Amps	0.5	0.5
Contact Rating	Max DC/Peak AC Resist.	Watts	3	3
Life Expectancy-Typical ¹	Signal Level 1.0V,10mA	x 10 ⁶ Ops.	1000	1000
Life Expectancy-Typical ¹	5.0V,10mA	x 10 ⁶ Ops.	100	100
Static Contact Resistance (max. init.)	50mV, 10mA	Ω	0.15	0.15
Dynamic Contact Resistance (max. init.)	0.5V, 50mA at 100 Hz, 1.5 msec	Ω	0.200	0.200
RELAY SPECIFICATIONS				
Insulation Resistance (minimum)	Between all Isolated Pins at 100V, 25°C, 40% RH	Ω	10 ¹²	10 ¹²
Capacitance - Typical Across Open Contacts	No Shield	pF	-	-
	Shield Floating	pF	-	-
	Shield Guarding	pF	-	0.2
Open Contact to Coil	No Shield	pF	-	-
	Shield Floating	pF	-	-
	Shield Guarding	pF	-	0.5
Closed Contact to Coil	Shield Guarding	pF	-	0.5
Contact to Shield	Contacts Open, Shield Floating	pF	-	-
Dielectric Strength (minimum)	Between Contacts	VDC/peak AC	160	160
	Contacts to Shield	VDC/peak AC	-	1500
	Contacts/Shield to Coil	VDC/peak AC	1500	1500
Operate Time - including bounce - Typical	At Nominal Coil Voltage, 30 Hz Square Wave	msec.	0.25	0.25
Release Time - Typical	Zener-Diode Suppression ³	msec.	0.05	0.05

Top View:
Dot stamped on top of relay refers to pin #1 location

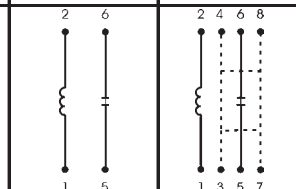

Notes:

- ¹ Consult factory for life expectancy at other switching loads. Contact resistance 2.0Ω defines end of life.
- ² Surface mount component processing temperature: 500°F (260°C) max for 1 minute dwell time. Temperature measured on leads where lead exits molded package.
- ³ Consists of 56V Zener diode and 1N4148 diode in series, connected in parallel with coil.

Environmental Ratings

Storage Temp: -35°C to +100°C; Operating Temp: -20°C to +85°C
 The operate and release voltage and the coil resistance are specified at 25°C. These values vary by approximately 0.4%/°C as the ambient temperature varies.
 Vibration: 20 G's to 2000 Hz; Shock: 50 G's
 Moisture Sensitivity per J-STD-020B, Level 2